

IC2
1x 555 SOIC-8
Farnell 9589880

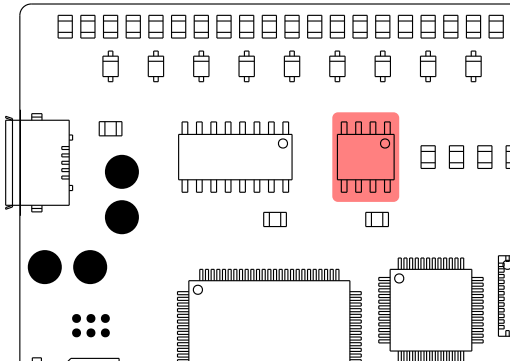

J1
1x MICROUSB MICROUSB_MOLEX_47589-00
Farnell 1568023

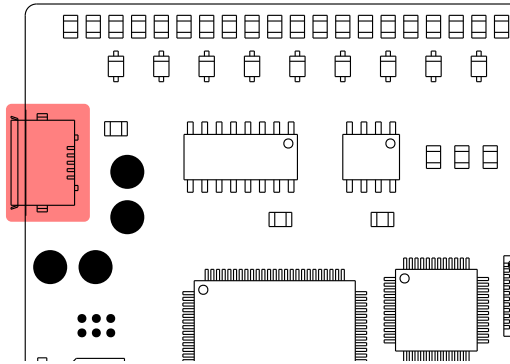

C8
1x 1μ 0603-L
Farnell 2496916

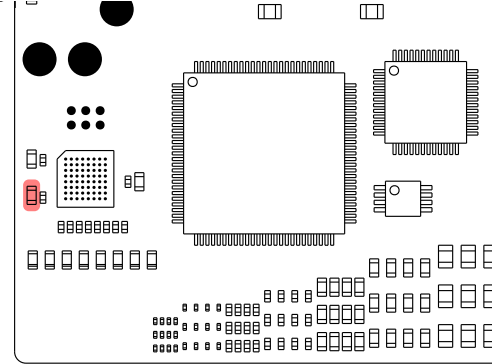

IC1
1x 4017 SOIC-16
Farnell 1085280

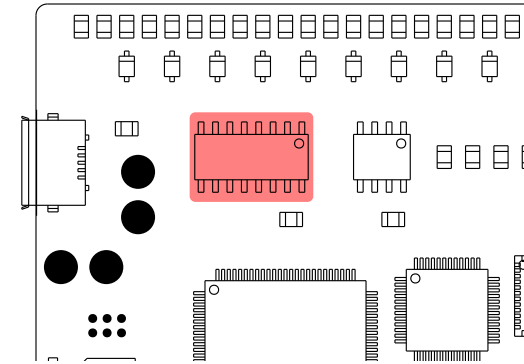

R105 R104 R106 R107 R108 R109 R110
8x 1k 0402-L
Farnell 2447587

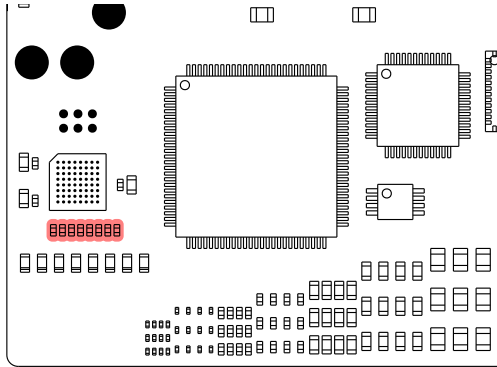

C10 C9
2x 100n 0402-L
Farnell 1759380

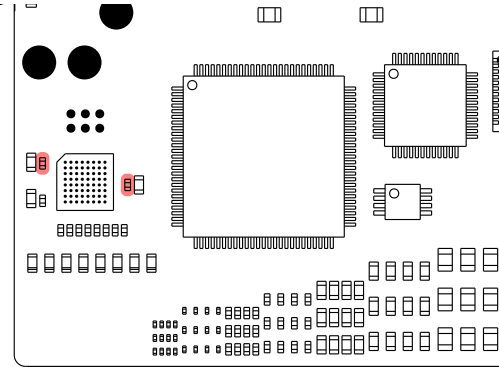

IC3
1x STM32F091RxHx UFBGA-64
Farnell 2503242

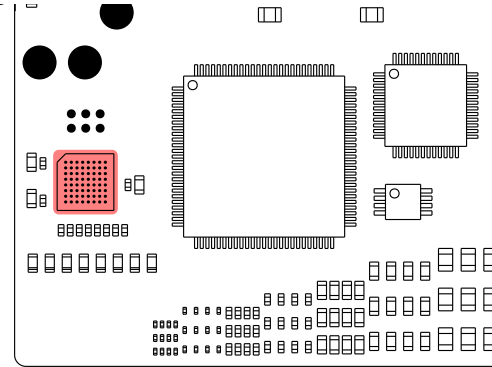

C11
1x 10n 0402-L
Farnell 1758924

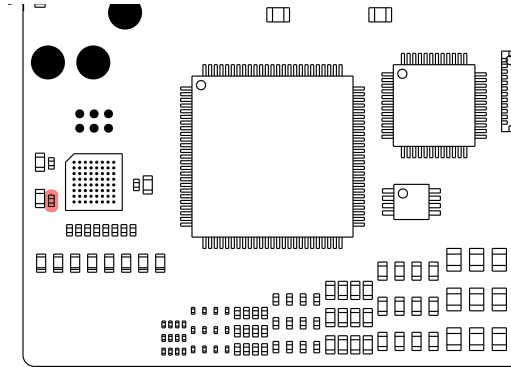

C3 C4 C1 C2
4x 100n 0805
Farnell 2496944

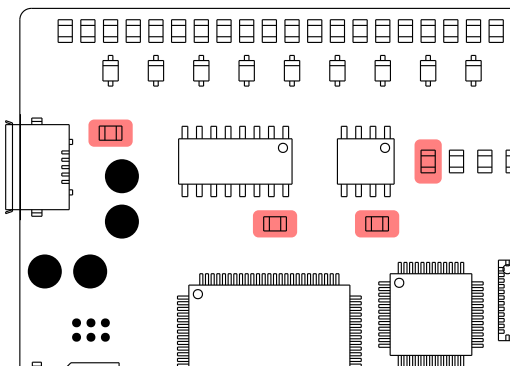

D23 D22 D24 D25 D26 D27 D28 D29
8x LED 0603-LED
Farnell 2290329

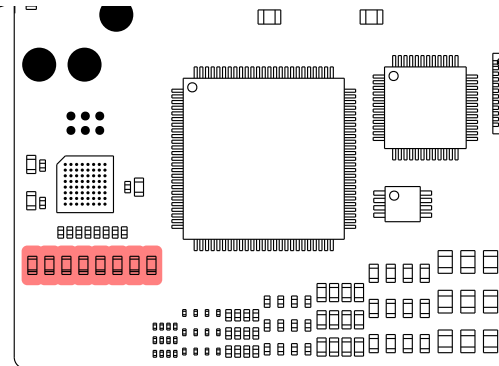

D11 D12 D13 D14 D15 D16 D17 D18 D19
11x LED 0805-LED
Farnell 5790840

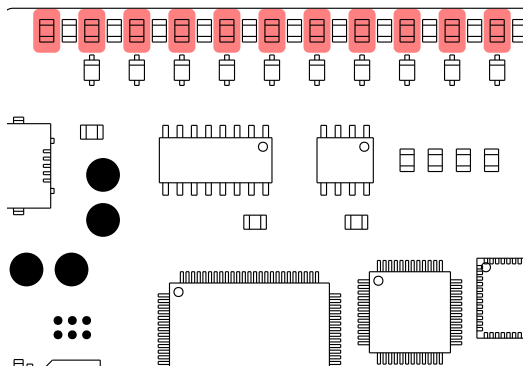

C7 C6
2x 2μ2 0603-L
Farnell 2496923

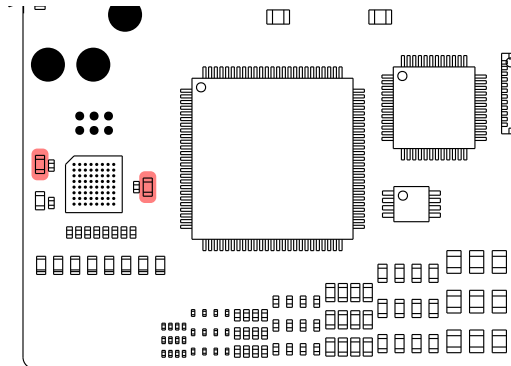

D2 D3 D4 D5 D7 D8 D9 D10 D1 D1 D6

10x ~ SOD-323
Farnell 1466524

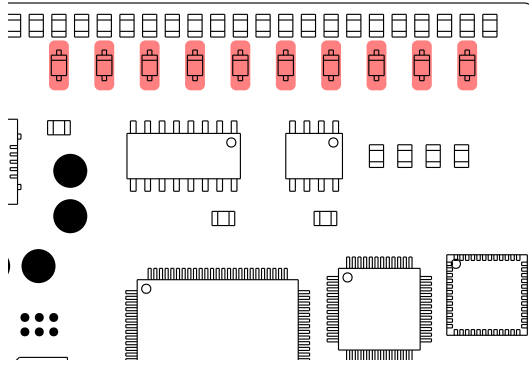

R5 R6 R7 R8 R4 R3 R9 R10 R11 R12 R13

11x 100 0805
Farnell 2447552

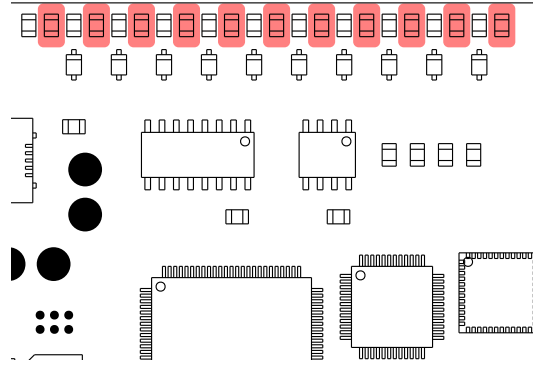

C5

1x 1μ 0805
Farnell 2497045

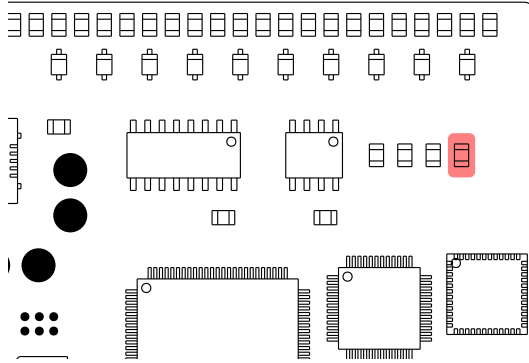

R1 R2

2x 100k 0805
Farnell 2447551

